



SMD-DC 型 陶瓷直流固定电容器
SMD d.c. ceramic capacitors

编 号/Number

TRX-3-081

制 定 日 期/Date

2024. 11.26

发 行 版 次/Issue

B2

页 码/Page

Page 1 of 28

规格承认书

Specification for approval

客户名称/CUSTOMER : _____ XX _____

客户料号/CUSTOMER P.N. : _____ / _____

特锐祥料号/TRX P.N.: _____ 见承认规格清单 _____

规格型号/MODEL NO. : _____ 见承认规格清单 _____

产品环保要求 Product environmental protection requirements	RoHS 要求	REACH 要求	Halogen 卤素要求
	■	■	■

制作/prepare	客户确认 (签署) / customer to confirm (signed)
	<p>(签认后, 敬请惠还壹份) (signed subscription, please also one copy)</p>
审核/check	
/	
批准/approve	
SUNNY	



TRX 特锐祥

专 注 电 容 器

www.trxc.net

Add: 四川省绵阳市游仙经开区三江路 1 号/安徽省阜阳市颍上县经济开发区迎宾大道 0016 号

Tel: +86-816-6039188

Fax: +86-816-6039198

Email: jun@trxc.net cw02@trxc.net



SMD-DC 型 陶瓷直流固定电容器
SMD d.c. ceramic capacitors

编 号/Number	TRX-3-081	制定日期/Date	2024. 11.26
发行版次/Issue	B2	页 码/Page	Page 2 of 28

变更履历表/E.C.LIST

物料名称 Material name	SMD-DC.CAP		特锐祥料号 TRX P.N.	见规格清单 See specification list	
规格型号 Model NO.	见规格清单 See specification list	资料编号 Data number	/	日期 Date	2024- 11-26
项 目 Item	日期 Date	版本 Edition	变更原因 Reason	备注 Remarks	
1	2019- 10-30	新版 New Version	内容更详细 More detailed content		
2	2023-05-08	A1	修改测试条件 Modify test conditions		
3	2023- 12-06	B0	更换版本 Change version		
4	2024-06-04	B1	更改推荐焊接条件 Change recommended soldering condition	见 8.推荐焊接条件 See 8. Recommended soldering condition	
5	2024- 11-26	B2	新增安徽工厂 Added Anhui production plant		
修改 Modify		审核 Check	/	批准 Approve	SUNNY



TRX 特锐祥
专 注 电 容 器

[www. trxc. net](http://www.trxc.net)

Add: 四川省绵阳市游仙经开区三江路 1 号/安徽省阜阳市颍上县经济开发区迎宾大道 0016 号
Tel : +86-816-6039188
Fax : +86-816-6039198
Email: jun@trxc.net cw02@trxc.net



SMD-DC 型 陶瓷直流固定电容器
SMD d.c. ceramic capacitors

编 号/Number	TRX-3-081	制定日期/Date	2024. 11.26
发行版次/Issue	B2	页 码/Page	Page 3 of 28

附页/ attached sheet:

承认规格/Recognized specifications

序号 CODE	客户料号 CUSTOMER P.N.	特锐祥料号 TRXP.N.	规格型号 MODELNO.	备注 REMARKS
1	/	TDDC472MA	SMD-Y5U472M/ 1KV A3	
2	/	TDDC472MO	SMD-Y5U472M/2KV A3	
3	/	TDDC472ME	SMD-Y5U472M/3KV A3	
4	/	TDDC103MA	SMD-Y5V103M/ 1KV A3	
5	/	TDDC103MO	SMD-Y5V103M/2KV A3	
6	/	TDDC103ME	SMD-Y5V103M/3KV A3	
7				
8				
9				
10				
11				
12				
13				
14				
15				
16				
17				
18				
19				
20				
21				
22				
23				
24				
25				
26				
27				
28				
29				
30				

关于 I、II、III 类瓷介固定电容器承认书规格型号说明:

About the class I, II, III ceramic dielectric fixed capacitor acceptance specifications:

适用于电子设备中使用的具有确定温度系数 (I 类介质), 具有高介电常数 (II 类介质) 和具有半
导体性质 (III 类介质) 的瓷介固定电容器。

This standard is applicable to fixed capacitors of ceramic dielectric with a defined temperature coefficient
(dielectric class I, class II, class III), intended for use in electronic equipment.

编 号/Number	TRX-3-081	制定日期/Date	2024. 11.26
发行版次/Issue	B2	页 码/Page	Page 4 of 28

目录/CONTENT

1. 品名说明 Name Description -----	5
2. 产品印标 Product marking: -----	5
3. 电容器标志代码 Capacitor sign code-----	6-7
4. 陶瓷电容器温度系数/温度特性 Temperature characteristics of product description-----	7
5. 陶瓷电容器介质说明 Ceramic capacitor dielectric description -----	8
6. 气候类别 Climatic category-----	8-9
7. 产品结构 Product structure -----	9- 10
8. 推荐焊接条件 Recommended soldering condition -----	10- 11
9. 性能和测试方法 Performance and test methods-----	11-21
10. 包装 Packing-----	22-23
11. 有毒有害物质含量控制要求 Content of toxic and harmful substances control requirements-----	24
12. 引用标准 Normative references-----	24-25
13. 术语和定义 Terms and definitions-----	25
14. 贮存条件 Storage conditions-----	26
15. 注意事项 Application notes-----	26
16. 陶瓷电容器的一般知识 general knowledge for ceramic Capacitors-----	27
17. 电容高压测试操作指引 Voltage proof test guide-----	27-28

编 号/Number	TRX-3-081	制定日期/Date	2024. 11.26
发行版次/Issue	B2	页 码/Page	Page 5 of 28

1. 品名说明/Name Description : (eg:)

料号/Maker part No: **TDDC103MA**

料号说明: T:TRX; D : SMD 封装; DC: 中高压直流瓷片; 103: 容量; M : 容差±20% ; A : 额定电压 1KV

规格/Model No. : **SMD-Y5V 103 M/1KV A3**

① ② ③ ④ ⑤ ⑥

No.	代码/Code	说明/Explain
①	SMD	塑料封装 L 管脚贴片/Plastic encapsulated L pin patch
②	Y5V	介质代码 / code of Dielectric B(Y5P) / E(Y5U) / F(Y5V)
③	103	容量: 前两位表示有效数字, 最后一位为乘方数。 Capacitance : The first two digits represent significant numbers, and the last digit is a multiplier. (eg: 103= 10×10 ³ = 10000pF)
④	M	容差 / Capacitance tolerance K(±10%) / M(±20%)
⑤	1KV	额定电压 / Rated voltage 1 KV / 2 KV/ 3 KV
⑥	A3 (10596)	本体尺寸/Body Dimension (L*W) : 10.5mm×9.6mm

2. 产品印标/ Product marking: (eg:)

Marking	四川产品打标 Sichuan product marking	安徽产品打标 Anhui product marking
		

说明/Explanation

	公司注册商标/品牌 registered trademark/ brand
103	容量: 前两位表示有效数字, 最后一位为乘方数。 Capacitance : The first two digits represent significant numbers, and the last digit is a multiplier. (eg: 103= 10×10 ³ = 10000pF)
M	容差 / Capacitance tolerance K(±10%)/M(±20%)
A	额定电压 / Nominal capacity A(1KV)/O(2KV)/E(3KV)
F	介质代码 / code of Dielectric B(Y5P)/E(Y5U)/F(Y5V)
S1115 / 3S1115	四川日期代码/安徽日期代码 Sichuan date code/ Anhui date code

以上提到的各种代码为本公司规定标准应用!

Various code mentioned above for the company standard application!

编 号/Number	TRX-3-081	制定日期/Date	2024. 11.26
发行版次/Issue	B2	页 码/Page	Page 6 of 28

3. 电容器标志代码/Capacitor sign code

- (1) 引用标准/Normative references : GB/T 2691- 1994
 (2) 电阻器和电容器的标志代码/Marking codes for resistors and capacitors
 (3) 电容量单位/capacitance unit: 法拉 farad (F)
 (4) 常用单位有/usual practical units: 皮法(pF) , 纳法(nF) , 微法(uF) , 毫法(mF)
 单位间的关系/Relationships between units: $1F= 10^3mF= 10^6uF= 10^9nF= 10^{12}pF$
 (5) 电容量代码/capacitance code

电容量代码用三位数表示, 前两位表示有效数字, 后一位表示有效数字后面零的个数, 换成容量后的单位是 pF。 (带小数点的容量则用P代小数点) 例如:

Codes for capacitance shall be find expression in three numbers. The first two digits are significant, and the third digit is number of zero. Into capacity unit is pF(Capacity p with decimal point the decimal point) for example:

容量代码 Capacitance Code	
代码 CODE	容量 CAPACITANCE
0P5	0.5PF
050	5PF
100	10PF
500	50PF
101	100PF
102	1000PF
223	22000PF

- (6) 电容量允许偏差/capacitance tolerance

代码 CODE	偏差 TOLERANCE
C	$\pm 0.25PF$
D	$\pm 0.5PF$
J	$\pm 5\%$
K	$\pm 10\%$
M	$\pm 20\%$
S	$+50/-20\%$
Z	$+80/-20\%$

编 号/Number	TRX-3-081	制定日期/Date	2024. 11.26
发行版次/Issue	B2	页 码/Page	Page 7 of 28

(7) 制造日期代码/Manufacturing date codes

年代码 code of year		月代码 code of month		日代码 code of day					
year	code	year	code	month	code	day	code	day	code
		2020	M	1	01	1	01	16	16
		2021	N	2	02	2	02	17	17
2010	A	2022	P	3	03	3	03	18	18
2011	B	2023	R	4	04	4	04	19	19
2012	C	2024	S	5	05	5	05	20	20
2013	D	2025	T	6	06	6	06	21	21
2014	E	2026	U	7	07	7	07	22	22
2015	F	2027	V	8	08	8	08	23	23
2016	H	2028	W	9	09	9	09	24	24
2017	J	2029	X	10	10	10	10	25	25
2018	K			11	11	11	11	26	26
2019	L			12	12	12	12	27	27
						13	13	28	28
						14	14	29	29
						15	15	30	30
								31	31

注：年份代码每 20 年为一周期重复一次。

Note: the year code repeats once every 20 years for a one-week period.

4. 陶瓷电容器温度系数/温度特性/Temperature characteristics of product description

CC1 CC81 系列 (ppm/°C)		CT1 CT81 CS1 系列	
代码 CODE	材质 DIELECTRIC	代码 CODE	材质 DIELECTRIC
CH	NP0(0±60)	A	Y5E (±4.7%)
LH	N80(-80±60)	B	Y5P (±10%)
PH	N150(-150±60)	X	X7R (±15%)
RH	N220(-220±60)	LR	Y5R (±15%)
SH	N330(-330±60)	E	Y5U (+22~-56%)
TH	N470(-470±60)	F	Y5V (+22~-82%)
UJ	N750(-750±60)	LB	BN (±10%)
SL	SL(+350~-1000)	T	Y5T (+22~-33%)
D	DL(-3300±500)		

介质种类前面的数字表示类别，如 2B 表示 II 类 B 特性，3B 表示 III 类 B 特性。

LR 和 LB 为低损耗材质。

Media type the number before the categories, such as 2B for class II B properties, 3B for class III B characteristics. LR and LB for low loss material.

编 号/Number	TRX-3-081	制定日期/Date	2024. 11.26
发行版次/Issue	B2	页 码/Page	Page 8 of 28

5. 陶瓷电容器介质说明/ Ceramic capacitor dielectric description

引用标准/Normative references : EIA- 198-D (CT1 CT81 CS1 系列)

第一字母: 使用温度下限 First letter: Low temp	第二数字: 使用温度上限 Second number: High Temp	第三字母: 使用温度范围内的容量变化率 Third letter: within the temperature range of volume rate of capacitance	
Y: -30°C	4: +65°C	A: ± 1.0%	P: ± 10%
Z: + 10°C	5: +85°C	B: ± 1.5%	R: ± 15%
X: -55°C	6: + 105°C	C: ± 2.2%	S: ± 22 %
	7: + 125°C	D: ± 3.3%	T: +22/-33%
	8: + 150°C	E: ± 4.7%	U: +22/-56%
		F: ± 7.5%	V: +22/-82%

6. 气候类别/Climatic category

根据环境影响评估标准 RS 198

According to EIA STANDARD RS 198

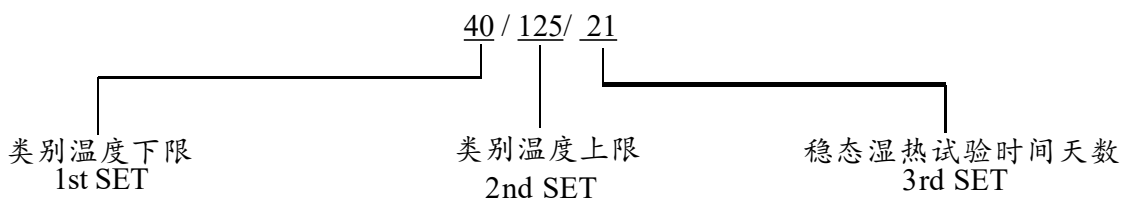

1st SET : 操作的最低环境温度(冷态试验)/Minimum ambient temperature of operation (Cold test)

2nd SET: 运行的最高环境温度(干热试验)/Maximum ambient temperature of operation (Dry heat test)

3rd SET : 天数 (稳态湿热试验)/Number of days (Damp heat steady state test)

等级举例/Category Examples
根据 IEC 60068- 1
according to IEC 60068- 1

25/085/04

40/085/21

55/ 125/21

55/ 125/56

第一组/First set

两位数字表示操作的最低环境温度(冷态试验)
Two digits denoting the minimum ambient
temperature of operation (Cold test)

65	-65°C
55	-55°C
40	-40°C
25	-25°C
10	-10°C
00	0°C
05	+5°C

编 号/Number	TRX-3-081	制 定 日 期/Date	2024. 11.26
发 行 版 次/Issue	B2	页 码/Page	Page 9 of 28

第二组 / Second set

三位数表示的最大工作环境温度(干热试验)
Three digits denoting the maximum ambient temperature of operation (Dry heat test)

155	+155°C
125	+125°C
110	+110°C
085	+85°C
080	+80°C
075	+75°C
070	+70°C

第三组 / Third set

两位数字表示的数天(稳态湿热试验)
Two digits denoting the number of days (Damp heat steady state test)

56	56 days
21	21 days
10	10 days
04	4 days
00	The component is not required to be exposed to damp heat

7.产品结构/ Product structure

7.1 产品尺寸/Product Dimension

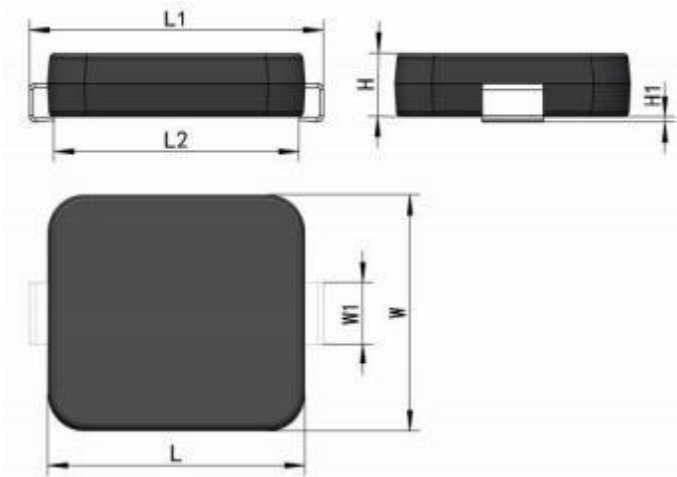

产品尺寸
Product Dimension(mm)

L	10.5±0.5	W	9.6±0.5
L1	12±0.5	W1	2.5±0.1
L2	10.5±0.5	H	2.58±0.1
H1	0.15±0.05		

7.2 产品构造/Product structure

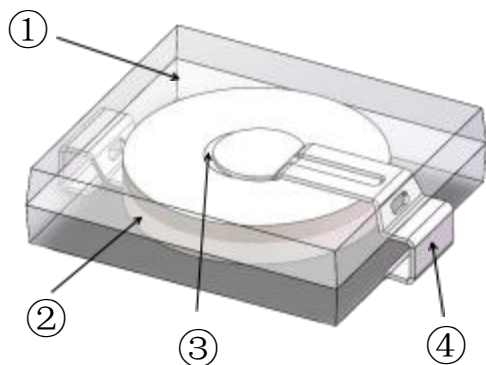

No.	名称 Part name	材料 Material
①	包封层 Coating	环氧树脂 (UL94V-0) Epoxy molding compound (UL94V-0)
②	芯片 Chip	陶瓷芯片 Ceramic chip
③	焊料 Solder	Sn-Pb- Ag 焊料 Sn- Pb- Ag Solder
④	引脚 Lead Pin	铜合金 Copper alloy
		镀锡层 Tin coating

7.3 推荐焊盘/Land Dimensions

下面是回流焊的推荐焊接尺寸。尺寸 a 是为了保证设备要求的安全标准爬行距离。

The recommendable land dimensions for reflow soldering are follows. Regarding the “a” dimension to ensure the creepage distance required by the safety standard appliess to your equipment.

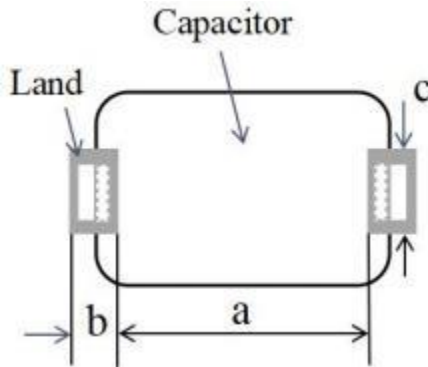

封装尺寸 Package Dimension	a(mm)	b(mm)	c(mm)
10.5×9.6	10.0min	2.2±0.1	3.6±0.1

8. 推荐焊接条件/ Recommended soldering condition

8.1 回流焊/Reflow Soldering

焊接电容器时，应在以下条件下进行，且连续焊接次数不能大于三次。

When soldering capacitor, it should be performed in following conditions . and the continuous welding times shuld not exceed three times.

峰值温度：260±5℃

Peak temperature : 260±5℃

焊接时间：最大 120 秒。

Soldering time: 120s max

预热温度：最大 150℃

Preheating temperature: 150℃ max

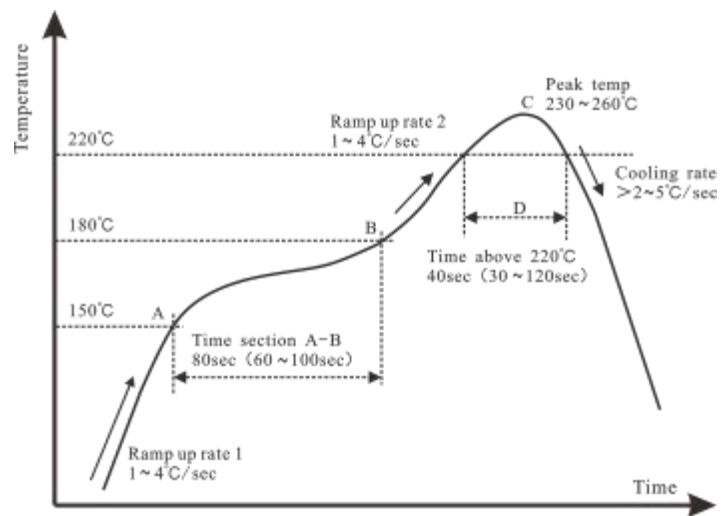

推荐回流焊曲线图/Recommended reflow soldering curve chart

8.2 波峰焊/Wave Soldering

焊接电容器时，应在以下条件下进行，且连续焊接次数不能大于三次。

When soldering capacitor, it should be performed in following conditions . and the continuous welding times shuld not exceed three times.

峰值温度：260±5℃

Peak temperature : 260±5℃

焊接时间：最大 10 秒。

Soldering time: 10s max.

预热温度：最大 100℃。

Preheating temperature: 100℃ max.

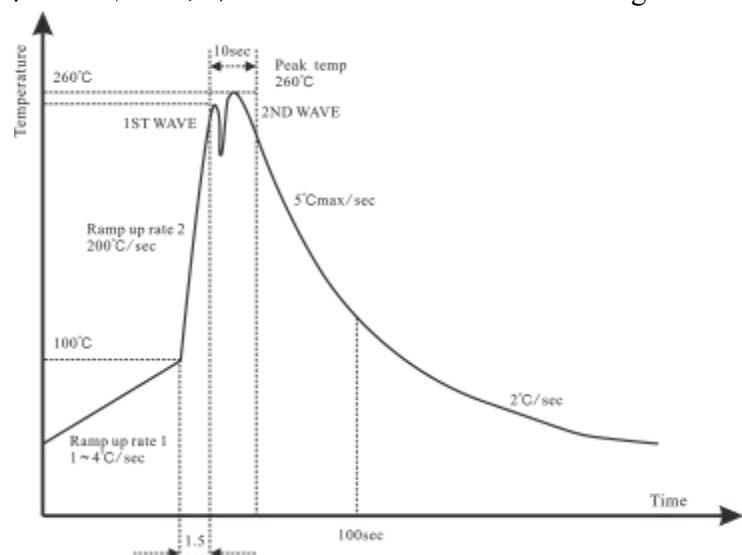

推荐波峰焊曲线图/Recommended Wave Soldering curve chart

编 号/Number	TRX-3-081	制定日期/Date	2024. 11.26
发行版次/Issue	B2	页 码/Page	Page 11 of 28

8.3 烙铁焊/Soldering Iron

将本产品焊接至 PCB/PWB 时，不得超过电容器的焊接耐热性规格。将本产品过度加热可能会融化内部连接焊料，并可能导致热冲击，从而导致陶瓷元件开裂。

When soldering this product to a PCB/PWB, do not exceed the solder heat resistance specification of the capacitor. Subjecting this product to excessive heating could melt the internal junction solder and may result in thermal shocks that can crack the ceramic element.

用烙铁焊接电容器时，应在下列条件下进行。

When soldering capacitor with a soldering iron, it should be performed in following conditions.

烙铁尖温度：最大 400°C。

Temperature of iron-tip : 400°C max.

烙铁瓦数：最大 50 瓦。

Soldering iron wattage : 50W max.

焊接时间：最大 5 秒。

Soldering time : 5s max.

9. 性能和测试方法/ Performance and test methods

CLASS I

NO	项目 Item	规范 Specification	测试方法 test method									
1	适用温度范围 Operating temperature rang	-40~+125°C , 包括电容器自身发热 -40~+125°C, Includes capacitors heating	可在此温度范围内连续使用 This continuous use temperature range									
2	外观和尺寸检查 Appearance and size check	元件表面清洁，无异物附着，标志清晰， 无可见损伤，尺寸符合规定要求 Component surfaces clean, as attachment, mark clear, no visible damage, dimensional compliance require ments	目测检查产品外观 尺寸用游标卡尺检查 Visually inspect the product appearance Dimension checked by calipers.									
3	电容量 Capacitance	在允许的偏差等级范围内 Within the scope of the permitted deviation level	测试温度/Testing temperature : 25 ±3°C									
4	损耗角正切(tgδ) (品质因素: Q) (注: tgδ=1/Q) Dissipation factor	<table border="1"> <tr> <td>Cap.</td> <td>Q</td> <td>tgδ</td> </tr> <tr> <td>C < 30pF</td> <td>≥400+20C</td> <td>1/Q</td> </tr> <tr> <td>C ≥ 30pF</td> <td>≥400</td> <td>≤0.0025</td> </tr> </table>	Cap.	Q	tgδ	C < 30pF	≥400+20C	1/Q	C ≥ 30pF	≥400	≤0.0025	测试频率/Testing frequency: f=1MHz±20% 测试电压/Testing voltage: 1.0±0.1Vrms
Cap.	Q	tgδ										
C < 30pF	≥400+20C	1/Q										
C ≥ 30pF	≥400	≤0.0025										
5	绝缘电阻 I.R.	IR ≥ 10000MΩ	<table border="1"> <tr> <td>额定电压 Rated voltage</td> <td>测试电压 applied voltage</td> <td>时间 time</td> </tr> <tr> <td>50、500V</td> <td>U_R</td> <td>60 ± 5s</td> </tr> <tr> <td>1KV、2KV 3KV、6KV</td> <td>500V</td> <td>60 ± 5s</td> </tr> </table>	额定电压 Rated voltage	测试电压 applied voltage	时间 time	50、500V	U _R	60 ± 5s	1KV、2KV 3KV、6KV	500V	60 ± 5s
额定电压 Rated voltage	测试电压 applied voltage	时间 time										
50、500V	U _R	60 ± 5s										
1KV、2KV 3KV、6KV	500V	60 ± 5s										

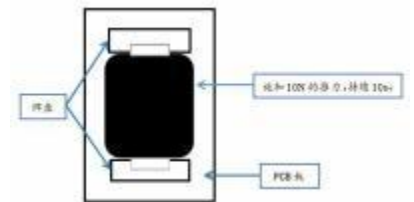
NO	项 目 Item	规 范 Specification	测 试 方 法 test method															
6	耐电压 voltage proof 端子之间 Between lead wire 端子与 外壳之间 Body insulation	无击穿或飞弧 No permanent break-down or flashover during the test period	<table border="1"> <thead> <tr> <th>额定电压 Rated voltage</th> <th>测试电压 applied voltage</th> <th>时间 time</th> </tr> </thead> <tbody> <tr> <td>50~500V</td> <td>2.5U_R</td> <td>60s</td> </tr> <tr> <td>1KV</td> <td>1.5U_R</td> <td>60s</td> </tr> <tr> <td>2KV、3KV</td> <td>1.5U_R+500</td> <td>60s</td> </tr> <tr> <td>6KV</td> <td>1.5U_R</td> <td>60s</td> </tr> </tbody> </table> <p>使用金属小球法，施加电压 DC1500V 测试 60s。 Used by metal balls, voltage application DC1500V testing 60s.</p>	额定电压 Rated voltage	测试电压 applied voltage	时间 time	50~500V	2.5U _R	60s	1KV	1.5U _R	60s	2KV、3KV	1.5U _R +500	60s	6KV	1.5U _R	60s
额定电压 Rated voltage	测试电压 applied voltage	时间 time																
50~500V	2.5U _R	60s																
1KV	1.5U _R	60s																
2KV、3KV	1.5U _R +500	60s																
6KV	1.5U _R	60s																
7	温度特性 Temperature characteristic	NP0: (0±60 ppm/°C) SL: (+350~-1000ppm/°C) DL: (-3300±500ppm/°C)	<p>在下列阶段温度测量容量值：基准 T3 Temperature measurements in the following phase capacity value: (for T3 in base)</p> <table border="1"> <thead> <tr> <th>步骤 step</th> <th>温度 Temperature</th> </tr> </thead> <tbody> <tr> <td>T1</td> <td>20±2°C</td> </tr> <tr> <td>T2</td> <td>-25±2°C</td> </tr> <tr> <td>T3</td> <td>20±2°C</td> </tr> <tr> <td>T4</td> <td>85±2°C</td> </tr> <tr> <td>T5</td> <td>20±2°C</td> </tr> </tbody> </table>	步骤 step	温度 Temperature	T1	20±2°C	T2	-25±2°C	T3	20±2°C	T4	85±2°C	T5	20±2°C			
步骤 step	温度 Temperature																	
T1	20±2°C																	
T2	-25±2°C																	
T3	20±2°C																	
T4	85±2°C																	
T5	20±2°C																	
8	终端粘合强度 Adhesive strength of termination	引线无断裂 Lead wire shall not cut off 本体无损伤 Capacitor shall not be broken 无可见损伤 No visible damage	<p>如图所示，将电容器焊接到 PCB 上，然后沿箭头方向施加 10N 的力。 Weld the capacitor to the PCB as shown in the figure, and then apply 10 N force in the direction of the arrow.</p> 															

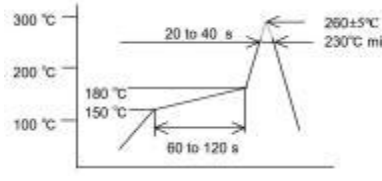
NO	项 目 Item	规 范 Specification	测 试 方 法 test method															
9	外观检查 Appearance check	无可见损伤, 标志清晰 no visible damage, mark clear	回流条件 (峰值) /Reflow(peak): $260 \pm 5^{\circ}\text{C}$ 焊接区/Solder zone : 230°C min. 20-40s.  标况下恢复 24±2 小时后测量 Measurement of recovery for 24 ± 2 hours under standard conditions															
	容量变化率 Capacitance change	NPO: $\pm 2\%$ SL: $\pm 5\%$ DL: $\pm 5\%$																
	绝缘电阻 I.R.	$IR \geq 10000M\Omega$																
	耐电压 voltage proof	无击穿或飞弧 No permanent break-down or flashover during the test period																
10	可焊性 Solderability	包锡良好(上锡率 90% 以上), 在 3 秒内流合。 Good tin coating (tin rate above 90%), within 3 seconds of convergence.	将电容器浸入乙醇(JIS K 8101)和松香(JIS K 5902)溶液中(松香重量比例为 25%)。(参考) Immerse the capacitor in the solution of ethanol (JIS K 8101) and rosin (JIS K 5902) (25% rosin in weight proportion). (Reference) 在焊料溶液中浸泡 $2 \pm 0.5\text{s}$ 。 Immerse in solder solution for $2 \pm 0.5\text{s}$ 。 焊料温度 Temp. of solder: $245 \pm 10^{\circ}\text{C}$															
11	温度快速变化 (温度循环) Rapid change of temperature (temperature cycling)	无可见损伤, 标志清晰 No visible damage. mark clear.	以下步骤为 1 个循环, 循环 5 次 Following step 1 loop, loop 5 times <table border="1" data-bbox="957 1433 1404 1702"> <thead> <tr> <th>步骤 step</th> <th>温度 Temperature</th> <th>时间 time</th> </tr> </thead> <tbody> <tr> <td>1</td> <td>$-40 \pm 2^{\circ}\text{C}$</td> <td>30minutes</td> </tr> <tr> <td>2</td> <td>$20 \pm 2^{\circ}\text{C}$</td> <td>3 minutes</td> </tr> <tr> <td>3</td> <td>$125 \pm 2^{\circ}\text{C}$</td> <td>30minutes</td> </tr> <tr> <td>4</td> <td>$20 \pm 2^{\circ}\text{C}$</td> <td>3 minutes</td> </tr> </tbody> </table>	步骤 step	温度 Temperature	时间 time	1	$-40 \pm 2^{\circ}\text{C}$	30minutes	2	$20 \pm 2^{\circ}\text{C}$	3 minutes	3	$125 \pm 2^{\circ}\text{C}$	30minutes	4	$20 \pm 2^{\circ}\text{C}$	3 minutes
步骤 step	温度 Temperature	时间 time																
1	$-40 \pm 2^{\circ}\text{C}$	30minutes																
2	$20 \pm 2^{\circ}\text{C}$	3 minutes																
3	$125 \pm 2^{\circ}\text{C}$	30minutes																
4	$20 \pm 2^{\circ}\text{C}$	3 minutes																
12	振动 Vibration	无可见损伤, 标志清晰 No visible damage. mark clear. 容 量 /Capacitance: $-20\% \leq \Delta C/C \leq +20\%$	频率/frequency: 10-55- 10Hz 振幅/amplitude of vibration: 1.5mm 方向: 上下、左右、前后 direction: Up and down, left and right, front and rear 时间/time : 2hours 状态: 正弦波振动 condition : sinusoidal wave															

NO	项 目 Item	规 范 Specification	测 试 方 法 test method		
13	冲击 Shock	外观：标志清晰，本体无可见损伤 No visible damage. mark clear. 容量/Capacitance：-20%≤ΔC/C≤+20%	条件 condition： 加速度 accelerated speed：490m/s ² 脉冲持续时间 pulse duration：11ms 方向/direction：X Y Z 次数/number of times：3times		
14	稳态 湿热 Damp heat steady state	外观检查 Appearance check	无可见损伤，标志清晰 No visible damage. mark clear.		
		容量变化率 capacitance change	NP0：±2%max SL：±5%max DL：±5%max		
		损耗角正切 D.F.	电容量 capacitance	Q	tgδ
			C < 30pF	≥200+ 10C	1/Q
			C ≥ 30pF	≥330	≤0.003
绝缘电阻 I.R.	5000MΩmin		温度 temperature 40±2℃ 相对湿度 Relative humidity 90%~95% 时间 time 500(+24/-0)Ho urs 标况下恢复 24±2 小时后测量 Measurement of recovery for 24 ± 2 hours under standard conditions		
15	稳态湿热 (负荷) Damp heat steady state (charge)	外观检查 Appearance check	无可见损伤，标志清晰 No visible damage. mark clear.		
		容量变化率 capacitance change	NP0：±2%max SL：±5%max DL：±5%max		
		损耗角正切 D.F.	CAP. (C)	Q	tg δ
			C < 30pF	≥200+ 10C	1/Q
			C ≥ 30pF	≥330	≤0.003
绝缘电阻 I.R.	5000MΩmin		温度 temperature 40±2℃ 相对湿度 Relative humidity 90%~95% 电压 voltage 额定电压 Rated voltage 时间 time 500(+24/-0)Hours 标况下恢复 24±2 小时后测量 Measurement of recovery for 24±2 hours under standard conditions		
16	耐久性 Endurance	外观检查 Appearance check	无可见损伤，标志清晰 No visible damage. mark clear.		
		容量变化率 capacitance change	NP0：±3%max SL：±5%max DL：±5%max		
		损耗角正切 D.F.	静电容量 capacitance	Q	tg δ
			C < 30pF	≥270+ 14C	1/Q
			C ≥ 30pF	≥330	≤0.003
绝缘电阻 I.R.	5000MΩmin		温度 temperature 125±2℃ 电压 voltage 1.5UR 时间 time 1000(+48/-0)hours 标况下恢复 24±2 小时内测量 Measurement of recovery for 24 ± 2 hours under standard conditions		

CLASS II

NO	项 目 Item	规 范 Specification	测 试 方 法 test method															
1	适用温度范围 Operating temperature rang	-40~+125℃，包括电容器自身发热 -40~+125℃，Includes capacitors heating	可在此温度范围内连续使用 This continuous use temperature range															
2	外观和尺寸检查 Appearance and size check	元件表面清洁，无异物附着，标志清晰， 无可见损伤，尺寸符合规定要求 Component surfaces clean, as attachment, mark clear, no visible damage, dimensional compliance requirements	目测检查产品外观 尺寸用游标卡尺检查 Visually inspect the product appearance Dimension checked by calipers.															
3	电 容 量 Capacitance	在允许的偏差等级范围内 Within the scope of the permitted deviation level	测试温度 Testing temperature : 25 ±3℃ 测试频率 Testing frequency: f=1KHz±20% 测试电压 Testing voltage: 1.0±0.1Vrms															
4	损耗角正切(tgδ) D.F.	2B、2E、2F、2X: tgδ≤0.025 LR、LB: tgδ≤0.015																
5	绝缘电阻 I.R	IR ≥ 4000MΩ	<table border="1"> <thead> <tr> <th>额定电压 Rated voltage</th> <th>测试电压 applied voltage</th> <th>时间 time</th> </tr> </thead> <tbody> <tr> <td>50、500V</td> <td>U_R</td> <td>60±5s</td> </tr> <tr> <td>1KV、2KV 3KV、6KV</td> <td>500V</td> <td>60±5s</td> </tr> </tbody> </table>	额定电压 Rated voltage	测试电压 applied voltage	时间 time	50、500V	U _R	60±5s	1KV、2KV 3KV、6KV	500V	60±5s						
额定电压 Rated voltage	测试电压 applied voltage	时间 time																
50、500V	U _R	60±5s																
1KV、2KV 3KV、6KV	500V	60±5s																
6	耐电压 voltage proof	无击穿或飞弧 No permanent break-down or flashover during the test period	<table border="1"> <thead> <tr> <th>额定电压 Rated voltage</th> <th>测试电压 applied voltage</th> <th>时间 time</th> </tr> </thead> <tbody> <tr> <td>50、500V</td> <td>2.5U_R</td> <td>60s</td> </tr> <tr> <td>1KV</td> <td>2U_R</td> <td>60s</td> </tr> <tr> <td>2KV、3KV</td> <td>1.5U_R+500</td> <td>60s</td> </tr> <tr> <td>6KV</td> <td>1.5U_R</td> <td>60s</td> </tr> </tbody> </table>	额定电压 Rated voltage	测试电压 applied voltage	时间 time	50、500V	2.5U _R	60s	1KV	2U _R	60s	2KV、3KV	1.5U _R +500	60s	6KV	1.5U _R	60s
	额定电压 Rated voltage		测试电压 applied voltage	时间 time														
50、500V	2.5U _R	60s																
1KV	2U _R	60s																
2KV、3KV	1.5U _R +500	60s																
6KV	1.5U _R	60s																
	端子之间 Between lead wire 端子与外壳之间 Body insulation	使用金属小球法，施加电压 DC1500V 测试 60s。 Used by metal balls, voltage application DC1500V testing 60s。																

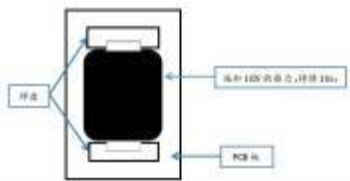
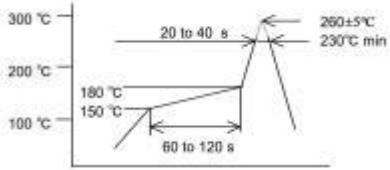
NO	项 目 Item	规 范 Specification	测 试 方 法 test method												
7	温度特性 Temperature characteristic	2B: (-10%~+10%) 2X: (-15%~+15%) LR: (-15%~+15%) 2E: (-56%~+22%) 2F: (-82%~+22%) LB: (-10%~+10%)	在下列阶段温度测量容量值：基准 T3 Temperature measurements in the following phase capacity value: (for T3 in base) <table border="1"> <thead> <tr> <th>步骤/step</th> <th>温度/Temperature</th> </tr> </thead> <tbody> <tr> <td>T1</td> <td>20±2°C</td> </tr> <tr> <td>T2</td> <td>-25±2°C</td> </tr> <tr> <td>T3</td> <td>20±2°C</td> </tr> <tr> <td>T4</td> <td>85±2°C</td> </tr> <tr> <td>T5</td> <td>20±2°C</td> </tr> </tbody> </table>	步骤/step	温度/Temperature	T1	20±2°C	T2	-25±2°C	T3	20±2°C	T4	85±2°C	T5	20±2°C
步骤/step	温度/Temperature														
T1	20±2°C														
T2	-25±2°C														
T3	20±2°C														
T4	85±2°C														
T5	20±2°C														
8	终端粘合强度 Adhesive strength of termination	引线无断裂 Lead wire shall not cut off 本体无损伤 Capacitor shall not be broken 无可见损伤 No visible damage	如图所示，将电容器焊接到 PCB 上，然后沿箭头方向施加 10N 的力。 Weld the capacitor to the PCB as shown in the figure, and then apply 10N force in the direction of the arrow 												
9	耐焊接热 Resistance to soldering heat	<table border="1"> <tr> <td>外观检查 Appearance check</td> <td>无可见损伤，标志清晰 no visible damage</td> </tr> <tr> <td>容量变化率 Capacitance change</td> <td> 2B、LR、LB: ±10%max 2X: ±15%max 2E、2F: ±20%max </td> </tr> <tr> <td>绝缘电阻 I.R</td> <td>IR ≥ 4000MΩ</td> </tr> <tr> <td>耐电压 voltage proof</td> <td> 无击穿或飞弧 No permanent break-down or flashover during the test period </td> </tr> </table>	外观检查 Appearance check	无可见损伤，标志清晰 no visible damage	容量变化率 Capacitance change	2B、LR、LB: ±10%max 2X: ±15%max 2E、2F: ±20%max	绝缘电阻 I.R	IR ≥ 4000MΩ	耐电压 voltage proof	无击穿或飞弧 No permanent break-down or flashover during the test period	回流条件（峰值）/Reflow(peak): 260±5°C 焊接区/Solder zone: 230°C min. 20-40s.  标况下恢复 24±2 小时后测量 Measurement of recovery for 24 ± 2 hours under standard conditions				
外观检查 Appearance check	无可见损伤，标志清晰 no visible damage														
容量变化率 Capacitance change	2B、LR、LB: ±10%max 2X: ±15%max 2E、2F: ±20%max														
绝缘电阻 I.R	IR ≥ 4000MΩ														
耐电压 voltage proof	无击穿或飞弧 No permanent break-down or flashover during the test period														
10	可焊性 Solderability	包锡良好(上锡率 90% 以上)，在 3 秒内流合。 Good tin coating (tin rate above 90%), within 3 seconds of convergence.	将电容器浸入乙醇(JIS K 8101)和松香(JIS K 5902)溶液中(松香重量比例为 25%)。(参考) Immerse the capacitor in the solution of ethanol (JIS K 8101) and rosin (JIS K 5902) (25% rosin in weight proportion). (Reference) 在焊料溶液中浸泡 2±0.5s。 Immerse in solder solution for 2±0.5s. 焊料温度 Temp. of solder: 245±10°C												

NO	项 目 Item	规 范 Specification	测 试 方 法 test method															
11	温度快速变化 (温度循环) Rapid change of temperature (temperature cycling)	外观检查: 无可见损伤, 标志清晰 Appearance check: No visible damage. mark clear.	以下步骤为 1 个循环, 循环 5 次 Following step 1 loop, loop 5 times <table border="1"> <thead> <tr> <th>步骤 step</th> <th>温 度 Temperature</th> <th>时 间 time</th> </tr> </thead> <tbody> <tr> <td>1</td> <td>-40±2℃</td> <td>30minutes</td> </tr> <tr> <td>2</td> <td>20±2℃</td> <td>3 minutes</td> </tr> <tr> <td>3</td> <td>125±2℃</td> <td>30minutes</td> </tr> <tr> <td>4</td> <td>20±2℃</td> <td>3 minutes</td> </tr> </tbody> </table>	步骤 step	温 度 Temperature	时 间 time	1	-40±2℃	30minutes	2	20±2℃	3 minutes	3	125±2℃	30minutes	4	20±2℃	3 minutes
步骤 step	温 度 Temperature	时 间 time																
1	-40±2℃	30minutes																
2	20±2℃	3 minutes																
3	125±2℃	30minutes																
4	20±2℃	3 minutes																
12	振 动 vibration	最后检查、测量和要求: Appearance check and measurement: 无可见损伤, 标志清晰 No visible damage. mark clear. 容量/Capacitance: -20%≤ΔC/C≤+20%	频率/frequency: 10-55- 10Hz 1minute 振幅/amplitude of vibration: 1.5mm 方向: 上下、左右、前后 Direction: Up and down, left and right, front and rear 时间/time : 2hours 状态: 正弦波振动 Condition: sinusoidal wave															
13	冲 击 shock	最后检查、测量和要求: Appearance check and measurement : 外观: 标志清晰, 本体无可见损伤 No visible damage. mark clear. 容量/Capacitance : -20%≤ΔC/C≤+20%	条件/condition: 加速度/accelerated speed : 490m/s ² 脉冲持续时间/pulse duration: 11ms 方向/direction : X Y Z 次数/number of times : 3times															
14	稳 态 湿 热 Damp heat steady state	外观检查 Appearance check	无可见损伤, 标志清晰 No visible damage. mark clear.															
		容量变化率 capacitance change	2B、LR、LB: ± 10%max 2X: ± 15%max 2E、2F: ±20%max															
		损耗角正切 D.F.	LR、LB: 0.025max 2B、2X: 0.050max 2E、2F: 0.070max															
		绝缘电阻 I.R	2000MΩmin															
			<table border="1"> <tbody> <tr> <td>温 度 temperature</td> <td>40±2℃</td> </tr> <tr> <td>相 对 湿 度 Relative humidity</td> <td>90%~95%</td> </tr> <tr> <td>时 间 time</td> <td>500(+24/-0)Hours</td> </tr> </tbody> </table> 标况下恢复 24±2 小时后测量 Measurement of recovery for 24 ± 2 hours under standard conditions	温 度 temperature	40±2℃	相 对 湿 度 Relative humidity	90%~95%	时 间 time	500(+24/-0)Hours									
温 度 temperature	40±2℃																	
相 对 湿 度 Relative humidity	90%~95%																	
时 间 time	500(+24/-0)Hours																	

NO	项 目 Item	规 范 Specification	测 试 方 法 test method										
15	外观检查 Appearance check	无可见损伤, 标志清晰 No visible damage. mark clear.	<table border="1"> <tr> <td>温度 temperature</td> <td>40±2℃</td> </tr> <tr> <td>相对湿度 Relative humidity</td> <td>90%~95%</td> </tr> <tr> <td>电压 voltage</td> <td>额定电压 Rated voltage</td> </tr> <tr> <td>时间 time</td> <td>500(+24/-0)小时</td> </tr> <tr> <td colspan="2">标况下恢复 24±2 小时后测量 Measurement of recovery for 24 ± 2 hours under standard conditions</td> </tr> </table>	温度 temperature	40±2℃	相对湿度 Relative humidity	90%~95%	电压 voltage	额定电压 Rated voltage	时间 time	500(+24/-0)小时	标况下恢复 24±2 小时后测量 Measurement of recovery for 24 ± 2 hours under standard conditions	
	温度 temperature	40±2℃											
	相对湿度 Relative humidity	90%~95%											
	电压 voltage	额定电压 Rated voltage											
	时间 time	500(+24/-0)小时											
标况下恢复 24±2 小时后测量 Measurement of recovery for 24 ± 2 hours under standard conditions													
稳态湿热 (负荷) Damp heat steady state (charge)	容量变化率 capacitance change	2B、LR、LB: ±10%max 2X: ±15%max 2E、2F: ±20%max											
损耗角正切 D.F.	LR、LB: 0.025max 2B、2X: 0.050max 2E、2F: 0.070max												
绝缘电阻 I.F.	2000MΩmin												
16	外观检查 Appearance check	无可见损伤, 标志清晰 No visible damage. mark clear.	<table border="1"> <tr> <td>温度 temperature</td> <td>125±2℃</td> </tr> <tr> <td>电压 voltage</td> <td>1.5 倍额定电压</td> </tr> <tr> <td>时间 time</td> <td>1000 (+48/-0) 小时</td> </tr> <tr> <td colspan="2">标况下恢复 24±2 小时内测量 Measurement of recovery for 24 ± 2 hours under standard conditions</td> </tr> </table>	温度 temperature	125±2℃	电压 voltage	1.5 倍额定电压	时间 time	1000 (+48/-0) 小时	标况下恢复 24±2 小时内测量 Measurement of recovery for 24 ± 2 hours under standard conditions			
	温度 temperature	125±2℃											
	电压 voltage	1.5 倍额定电压											
	时间 time	1000 (+48/-0) 小时											
	标况下恢复 24±2 小时内测量 Measurement of recovery for 24 ± 2 hours under standard conditions												
耐久性 Endurance	容量变化率 capacitance change	2B、LB、LR: ±10%max 2X: ±15%max 2E、2F: ±20%max											
损耗角正切 D.F.	LR、LB: 0.025max 2B、2X: 0.050max 2E、2F: 0.070max												
绝缘电阻 I.R.	2000MΩmin												

CLASS III

NO	项 目 Item	规 范 Specification	测 试 方 法 test method
1	适用温度范围 Operating temperature rang	-40~+125℃, 包括电容器自身发热 -40~+125℃, Includes capacitors heating	可在此温度范围内连续使用 This continuous use temperature range
2	外观和尺寸检查 Appearance and size check	元件表面清洁, 无异物附着, 标志清晰, 无可见损伤, 尺寸符合规定要求 Component surfaces clean, as attachment, mark clear, no visible damage, dimensional compliance requirements	目测检查产品外观 尺寸用游标卡尺检查 Visually inspect the product appearance Dimension checked by calipers
3	电容量 Capacitance	在允许的偏差等级范围内 Within the scope of the permitted deviation level	测试温度 Testing temperature: 25 ±3℃ 测试频率 Testing frequency: f=1KHz±20%
4	损耗角正切(tgδ)	3B、3E、3F: (tg δ) ≤0.05	测试电压 Testing voltage: 1.0±0.1Vrms

NO	项 目 Item	规 范 Specification	测 试 方 法 test method												
5	绝缘电阻 I.R	$10V \leq U_R \leq 25V:$ $IR \geq 100M\Omega$ $U_R > 25V:$ $IR \geq 1000M\Omega$	<table border="1"> <thead> <tr> <th>额 定 电 压 Rated voltage</th> <th>测 试 电 压 Applied voltage</th> <th>时 间 time</th> </tr> </thead> <tbody> <tr> <td>10~100V</td> <td>U_R</td> <td>$60 \pm 5s$</td> </tr> </tbody> </table>	额 定 电 压 Rated voltage	测 试 电 压 Applied voltage	时 间 time	10~100V	U_R	$60 \pm 5s$						
额 定 电 压 Rated voltage	测 试 电 压 Applied voltage	时 间 time													
10~100V	U_R	$60 \pm 5s$													
6	耐电压 voltage proof	端子之间 Between lead wire 无击穿或飞弧 No permanent break-down or flashover during the test period 端子与 外壳之间 Body insulation	<table border="1"> <thead> <tr> <th>额 定 电 压 Rated voltage</th> <th>测 试 电 压 Applied voltage</th> <th>时 间 time</th> </tr> </thead> <tbody> <tr> <td>50V</td> <td>$1.5U_R$</td> <td>60s</td> </tr> <tr> <td>100V</td> <td>$1.5U_R$</td> <td>60s</td> </tr> </tbody> </table> <p>使用金属小球法，施加电压 DC150V 测试 60s。 Used by metal balls, voltage application DC150V testing 60s.</p>	额 定 电 压 Rated voltage	测 试 电 压 Applied voltage	时 间 time	50V	$1.5U_R$	60s	100V	$1.5U_R$	60s			
额 定 电 压 Rated voltage	测 试 电 压 Applied voltage	时 间 time													
50V	$1.5U_R$	60s													
100V	$1.5U_R$	60s													
7	温度特性 Temperature characteristic	3B: (-10%~+10%) 3E: (-56%~+22%) 3F: (-82%~+22%)	<p>在下列阶段温度测量容量值：基准 T3 Temperature measurements in the following phase capacity value: (for T3 in base)</p> <table border="1"> <thead> <tr> <th>步 骤/step</th> <th>温 度/Temperature</th> </tr> </thead> <tbody> <tr> <td>T1</td> <td>20 ± 2</td> </tr> <tr> <td>T2</td> <td>-25 ± 2</td> </tr> <tr> <td>T3</td> <td>20 ± 2</td> </tr> <tr> <td>T4</td> <td>85 ± 2</td> </tr> <tr> <td>T5</td> <td>20 ± 2</td> </tr> </tbody> </table>	步 骤/step	温 度/Temperature	T1	20 ± 2	T2	-25 ± 2	T3	20 ± 2	T4	85 ± 2	T5	20 ± 2
步 骤/step	温 度/Temperature														
T1	20 ± 2														
T2	-25 ± 2														
T3	20 ± 2														
T4	85 ± 2														
T5	20 ± 2														
8	终端粘合强度 Adhesive strength of termination	引线无断裂 Lead wire shall not cut off 本体无损伤 Capacitor shall not be broken 无可见损伤 No visible damage	<p>如图所示，将电容器焊接到 PCB 上，然后沿箭头方向施加 10N 的力。 Weld the capacitor to the PCB as shown in the figure, and then apply 10N force in the direction of the arrow.</p> 												

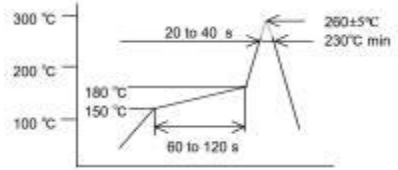
NO	项 目 Item	规 范 Specification	测 试 方 法 test method															
9	外观检查 Appearance check	无可见损伤, 标志清晰 No visible damage and clear marks	回流条件(峰值)/Reflow(peak): $260 \pm 5^{\circ}\text{C}$ 焊接区/Solder zone: 230°C min. 20-40s.  标况下恢复 24±2 小时后测量 Measurement of recovery for 24 ± 2 hours under standard conditions															
	耐焊接热 Resistance to soldering heat	容量变化率 Capacitance change 3B: $\pm 10\% \text{max}$ 3E、3F、 $\pm 20\% \text{max}$																
	绝缘电阻 I.R	$\text{IR} \geq 100\text{M}\Omega$																
	耐电压 voltage proof	在初期规格范围之内																
10	可焊性 Solderability	包锡良好(上锡率 90% 以上), 在 3 秒内流合。 Good tin coating (tin rate above 90%), within 3 seconds of convergence.	将电容器浸入乙醇(JIS K 8101)和松香(JIS K 5902)溶液中(松香重量比例为 25%)。(参考) Immerse the capacitor in the solution of ethanol (JIS K 8101) and rosin (JIS K 5902) (25% rosin in weight proportion). (Reference) 在焊料溶液中浸泡 $2 \pm 0.5\text{s}$ 。 Immerse in solder solution for $2 \pm 0.5\text{s}$ 。 焊料温度 Temp. of solder: $245 \pm 10^{\circ}\text{C}$															
11	温度快速变化 (温度循环) Rapid change of temperature (Temperature cycle)	外观检查: 无可见损伤, 标志清晰 Appearance check: No visible damage. mark clear.	以下步骤为 1 个循环, 循环 5 次 Following step 1 loop, loop 5 times <table border="1" data-bbox="949 1422 1396 1646"> <thead> <tr> <th>步骤 step</th> <th>温度 Temperature</th> <th>时间 time</th> </tr> </thead> <tbody> <tr> <td>1</td> <td>$-40 \pm 2^{\circ}\text{C}$</td> <td>30 minutes</td> </tr> <tr> <td>2</td> <td>$20 \pm 2^{\circ}\text{C}$</td> <td>3 minutes</td> </tr> <tr> <td>3</td> <td>$125 \pm 2^{\circ}\text{C}$</td> <td>30 minutes</td> </tr> <tr> <td>4</td> <td>$20 \pm 2^{\circ}\text{C}$</td> <td>3 minutes</td> </tr> </tbody> </table>	步骤 step	温度 Temperature	时间 time	1	$-40 \pm 2^{\circ}\text{C}$	30 minutes	2	$20 \pm 2^{\circ}\text{C}$	3 minutes	3	$125 \pm 2^{\circ}\text{C}$	30 minutes	4	$20 \pm 2^{\circ}\text{C}$	3 minutes
步骤 step	温度 Temperature	时间 time																
1	$-40 \pm 2^{\circ}\text{C}$	30 minutes																
2	$20 \pm 2^{\circ}\text{C}$	3 minutes																
3	$125 \pm 2^{\circ}\text{C}$	30 minutes																
4	$20 \pm 2^{\circ}\text{C}$	3 minutes																
12	振动 Vibration	最后检查、测量和要求: Appearance check and measurement: 无可见损伤, 标志清晰 No visible damage. mark clear. 容 量 /Capacitance : $-20\% \leq \Delta C / C \leq +20\%$	频率/frequency: 10-55- 10Hz 1minute 振幅/amplitude of vibration: 1.5mm 方向: 上下、左右、前后 Direction: Up and down, left and right, front and rear 时间/time : 2hours 状态: 正弦波振动 Condition: sinusoidal wave															

NO	项目 Item	规范 Specification	测试方法 test method								
13	冲击 Shock	最后检查、测量和要求: Appearance check and measurement: 外观: 标志清晰, 本体无可见损伤 No visible damage. mark clear. 容 量 /Capacitance : $-20\% \leq \Delta C/C \leq +20\%$	条件/condition: 加速度/accelerated speed : 490m/s ² 脉冲持续时间/pulse duration: 11ms 方向/direction : X Y Z 次数/number of times : 3times								
14	稳态 湿热 Damp heat steady state	外观检查 Appearance check	<table border="1"> <tr> <td>温度 temperature</td> <td>40±2°C</td> </tr> <tr> <td>相对湿度 Relative humidity</td> <td>90%~95%</td> </tr> <tr> <td>时间 time</td> <td>500(+24/-0)Hours</td> </tr> </table> <p>标况下恢复 24±2 小时后测量 Measurement of recovery for 24 ± 2 hours under standard conditions</p>	温度 temperature	40±2°C	相对湿度 Relative humidity	90%~95%	时间 time	500(+24/-0)Hours		
		温度 temperature		40±2°C							
		相对湿度 Relative humidity		90%~95%							
		时间 time		500(+24/-0)Hours							
容量变化率 capacitance change	3B: ±10%max 3E、3F: ±20%max										
损耗角正切 D.F.	3B: 0.07 max 3E、3F: 0.1max										
绝缘电阻 I.R	100MΩmin										
15	稳态湿热 (负荷) Damp heat steady state (charge)	外观检查 Appearance check	<table border="1"> <tr> <td>温度 temperature</td> <td>40±2°C</td> </tr> <tr> <td>相对湿度 Relative humidity</td> <td>90%~95%</td> </tr> <tr> <td>电压 voltage</td> <td>额定电压 Rated voltage</td> </tr> <tr> <td>时间 time</td> <td>500(+24/-0)Hours</td> </tr> </table> <p>标况下恢复 24±2 小时后测量 Measurement of recovery for 24 ± 2 hours under standard conditions</p>	温度 temperature	40±2°C	相对湿度 Relative humidity	90%~95%	电压 voltage	额定电压 Rated voltage	时间 time	500(+24/-0)Hours
		温度 temperature		40±2°C							
		相对湿度 Relative humidity		90%~95%							
		电压 voltage		额定电压 Rated voltage							
时间 time	500(+24/-0)Hours										
容量变化率 capacitance change	3B: ±10%max 3E、3F: ±20%max										
损耗角正切 D.F.	3B: 0.07 max 3E、3F: 0.1max										
绝缘电阻 I.R	100MΩmin										
16	耐久性 Endurance	外观检查 Appearance check	<table border="1"> <tr> <td>温度 temperature</td> <td>12±2°C</td> </tr> <tr> <td>电压 voltage</td> <td>1.5 倍额定电压</td> </tr> <tr> <td>时间 time</td> <td>1000 (+48/-0) 小时</td> </tr> </table> <p>标况下恢复 24±2 小时内测量 Measurement of recovery for 24 ± 2 hours under standard conditions</p>	温度 temperature	12±2°C	电压 voltage	1.5 倍额定电压	时间 time	1000 (+48/-0) 小时		
		温度 temperature		12±2°C							
		电压 voltage		1.5 倍额定电压							
		时间 time		1000 (+48/-0) 小时							
容量变化率 capacitance change	3B、3E、3F: ±20%max										
损耗角正切 D.F.	3B: 0.07max 3E、3F: 0.1max										
绝缘电阻 I.R	100MΩmin										

注: 上述测试均在标况下进行, “标况”解释如下

Note: the above tests are conducted under standard conditions, the "standard conditions" are explained in the following:

温度/temperature	相对湿度/temperature	气压/air pressure
15~35°C	45~85% R.H.	86~106kPa

当测试结果有争议是, 仲裁标况为/When the test results are at issue, the arbitration:

温度/temperature	相对湿度/temperature	气压/air pressure
25±1°C	48~52% R.H.	86~106kPa

编 号/Number	TRX-3-081	制定日期/Date	2024.11.26
发行版次/Issue	B2	页 码/Page	Page 22 of 28

10. 包装/Packing

10.1 载带尺寸/Dimension of tape

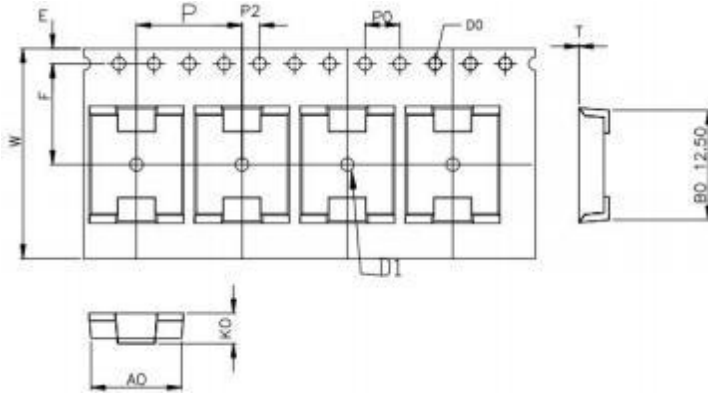

ITEM	W	E	F	P	P0	P2	D0	D1	T	B0	A0	K0
DIM	24.00 ^{+0.30} _{-0.30}	1.75 ^{+0.10} _{-0.10}	11.50 ^{+0.10} _{-0.10}	12.00 ^{+0.10} _{-0.10}	4.00 ^{+0.10} _{-0.10}	2.00 ^{+0.10} _{-0.10}	φ1.50 ^{+0.10} ₋₀	φ1.50 ^{+0.10} ₋₀	0.3 ^{+0.05} _{-0.05}	12.50 ^{+0.10} _{-0.10}	10.00 ^{+0.10} _{-0.10}	3.45 ^{+0.10} _{-0.10}

10.2 卷盘/REEL

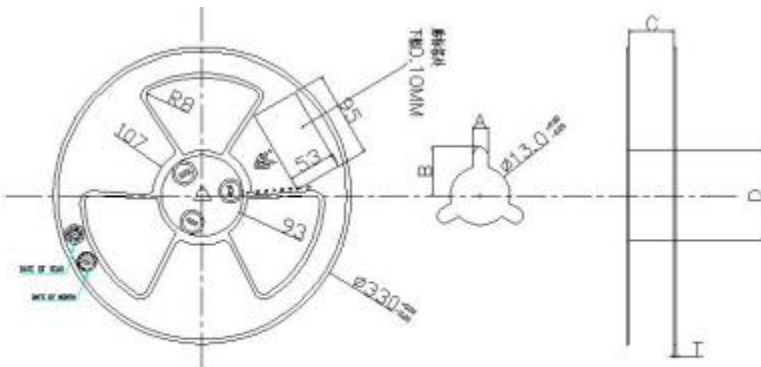

SPEC	A±0.3	B±0.5	C ^{+0.5} _{-0.0}	D±0.5	T±0.2
24	2.3	10.75	24.4	Ø97	2.2

REEL	REEL SIZE
1500pcs	1 3 inch

10.3 剥离强度/Peeling Strength

Item	Data	Remark
Cover tape adhesion	10 ~ 100g	Carrier tape and cover tape open angle 165 ~ 180° F=300± 5mm/minute

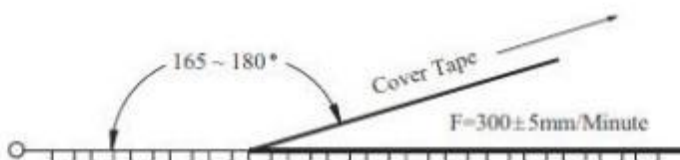

编 号/Number	TRX-3-081	制定日期/Date	2024. 11.26
发行版次/Issue	B2	页 码/Page	Page 23 of 28

10.4 包装数据表/Product Packaging Scheme

内 包 装 / inner- packaging:

内盘标签/Inner disc label	四川产品信息标签 / Sichuan Product Information Label	安徽产品信息标签 / Anhui Product Information Label	项 目/Item	
			TRX.Des	物料描述
TRX 料号			P/N	客户料号
			Mfr	特锐祥料号
卷盘尺寸/Reel Size: 13 inch 1.5 KPCS/Reel	密封袋上的标签 /Label on Sealed bag	湿敏标签 /Humidity sensitive label	D/C	生产日期
			Lot.No	生产批号
			Q~TY	数量
			SPEC	规格

外 包 装 / Outer- packaging:

																
图示 1 / Figure 1	图示 2 / Figure 2	图示 3 / Figure 3														
<table border="1"> <thead> <tr> <th colspan="3">尺寸 (mm) Dimension</th> <th>数量 Quantity</th> <th>外箱重量 Out Box Weight</th> </tr> <tr> <th>L</th> <th>W</th> <th>H</th> <td rowspan="2">13.5KPCS</td> <td rowspan="2">≈16KG</td> </tr> </thead> <tbody> <tr> <td>365</td> <td>358</td> <td>304</td> </tr> </tbody> </table>			尺寸 (mm) Dimension			数量 Quantity	外箱重量 Out Box Weight	L	W	H	13.5KPCS	≈16KG	365	358	304	
尺寸 (mm) Dimension			数量 Quantity	外箱重量 Out Box Weight												
L	W	H	13.5KPCS	≈16KG												
365	358	304														

包装示意图 / Package sketch:



外箱/Out Box



9 卷盘/盒/9 Reel/Box



托盘尺寸(长/宽/高)
Pallet Size(L/W/H)
1100*1100*90mm



堆放体积(长/宽/高)
Stacking volume(L/W/H)
1100*1100*1600mm

备注: 1. 包装箱上的“5”是堆叠层数不能超过 5 层; 2. PALLET 包装&远距离运输时 WRAPPING; 3. 50cm 以上高度不可抛落下; 4. 常温/常湿保管。
Remark: 1.The 5 on the packing is stacked layers can't more than 5 layers; 2. Pallets packaging & long-distance transport should be warpping; 3.50 cm above the height of the parcel do not drop; 4. Normal temperature / humidity keeping.

11. 有毒有害物质含量控制要求/Content of toxic and harmful substances control requirements

RoHS2.0 2011/65/EU

halogen 卤素

REACH No190 7/2006

RoHS H.F.
REACH

物质名称 Substances	含量 concentration (unit: ppm)
镉及镉化合物/Cadmium and cadmium compounds	< 100
铅及铅化合物/Lead and lead compounds	< 1000
汞及汞化合物/Mercury and mercury compounds	< 1000
铬及铬化合物/Hexavalent chromium compounds	< 1000
多溴联苯 PBBS/Polubrominated biphenyls	< 1000
多溴联苯醚 PBDES/Polubrominated diphenylethers	< 1000
镉+铅+汞+六价铬/Cd+Pb+ Hg + Cr+6(packing materials)	< 100
氯/Cl	<900
溴/Br	<900
氯+溴/Cl+Br	< 1500
REACH 高度关注物质 SVHC Substances of Very High Concern (SVHC) of REACH	以 TRX 最新REACH 报告为准 The latest reach report of TRX shall prevail

12. 引用标准/Normative references

GB/T 2693-2001 (IDT IEC 60384- 1: 1999): 电子设备用固定电容器 第 1 部分 总规范

Fixed capacitors for use in electronic equipment-Part 1: Generic specification

GB/T 2828. 1-2003 (IDT ISO 2859- 1:1999) : 计数抽样检验程序 第 1 部分 按接受限(AQL)检索的逐批检验抽样计划
Sampling procedures for inspection by attributes-Part 1: Sampling schemes indexed by acceptance quality limit(AQL) for lot-blot inspection

GB/T 2471- 1995 (IDT IEC 63:1963): 电阻器和电容器优先数系

Preferred number series for resistors and capacitors

GB/T 2691- 1994 (IDT IEC 62:1992): 电阻器和电容器的标志代码

Marking codes for resistors and capacitors

SJ/T 11363-2006: 电子信息产品中有毒有害物质的限量要求

Requirements for concentration limits for certain hazardous substances in electronic information products

SJ/T 11364-2006: 电子信息产品污染控制标识要求

Marking for control of pollution caused by electronic information products

SJ/T 11365-2006: 电子信息产品中有毒有害物质的检测方法

Testing methods for hazardous substances in electronic information products

2011/65/EU: (RoHS2.0) 电子电气设备中限制使用某些有害物质指令

The Restriction of the use of certain Hazardous substances in Electrical and Electronic Equipment

2002/96/EC (WEEE) : 废旧电子电气设备指令

Waste Electrical and Electronic Equipment

编 号/Number	TRX-3-081	制 定 日 期/Date	2024. 11.26
发 行 版 次/Issue	B2	页 码/Page	Page 25 of 28

94/62/EC (2005/20/EC) : 关于包装和包装废物的 1994 年 12 月 20 日欧洲议会和理事会指令
94/62/ECEurope Parliament and Council Directive94/62/EC of 20 December 1994 onPackaging and packaging waste
No1907/2006(REACH): 化学品注册、评估、许可和限制
Registration, Evaluation, Authorization and Restriction of Chemicals(155 item)

13. 术语和定义/Terms and definitions

- 1) I类瓷介固定电容器 Fixed capacitors of ceramic dielectric, class I
专门设计并用在低损耗, 电容量稳定性高或要求温度系数有明确规定的谐振电路中的一种电容器。例如在电路中作温度补偿之用。
Designed with low loss, high stability of capacitance or temperature coefficient is required to have clearly defined the resonant circuit of a capacitor. For example, in the circuit for temperature compensation purposes.
- 2) II类瓷介固定电容器 Fixed capacitors of ceramic dielectric, class II
适用于旁路耦合或用在对损耗和电容量稳定性要求不高的电路中的,具有高介电常数的一种电容器。
Applied to the bypass coupling or do not ask for much of the loss and capacitance stability circuit, a capacitor with a high dielectric constant.
- 3) III类瓷介固定电容器 Fixed capacitors of ceramic dielectric, class III
适用于作旁路和耦合之用的电路中, 具有半导体特征的一种电容器。
Apply for bypass and coupling circuit, a capacitor with semiconductor characteristics.
- 4) 额定电压 rated voltage
额定电压是在额定温度下, 可以连续施加在电容器引出端上的最大直流电压。
Either the r. m. s. operating voltage of rated frequency or the d. c. operating voltage, which may be applied continuously to the terminations of a capacitor at any temperature between the lower and the upper category temperatures.
- 5) 损耗角正切 tangent of loss angle($\tan \delta$)
在规定频率的正弦电压下, 电容器的损耗功率除以电容器的无功功率。
The power loss of the capacitor divided by the reactive power of the capacitor at a sinusoidal voltage at a specified frequency.
- 6) 上限类别温度 upper category temperature
电容器设计所确定的能连续工作和最高环境温度。
Maximum surface temperature for which the capacitor has been designed to operate continuously.
- 7) 下限类别温度 lower category temperature
电容器设计所确定的能连续工作和最低环境温度。
Minimum surface temperature for which the capacitor has been designed to operate continuously.
- 8) 电容量温度特性 temperature characteristic of capacitor
电容量温度特性是在一个不超出类别温度范围的给定温度范围内, 所出现的电容量最大可逆变化。一般此变化表示相对 20°C时电容量的百分比。
The maximum reversible variation of capacitance produced over a given temperature range within the category temperature range, normally expressed as a percentage of the capacitance related to a reference temperature of 20 °C .

编 号/Number	TRX-3-081	制 定 日 期/Date	2024. 11.26
发 行 版 次/Issue	B2	页 码/Page	Page 26 of 28

14. 贮存条件/Storage conditions

(1). 绝缘环氧树脂模制电容器未形成完美的密封; 因此,不要在腐蚀性环境中使用或储存电容器, 尤其是氯化物气体、硫化物气体、酸、碱、盐或类似物质都存在的环境, 还要避免暴露在潮湿的环境中。为了避免水分的吸收, 电容器应包装在防潮的密封袋里。

The insulating Epoxy molded capacitors does not form a perfect seal; therefore, do not use or store capacitors in a corrosive atmosphere, especially where chloride gas, sulfide gas, acid, alkali, salt or the like are present. And avoid exposure to moisture. So, in order to avoid the absorption of moisture, capacitors are packed in moisture- proof envelope.

(2). 电容器应在以下条件中储存, 并在交付后24个月内使用。

Store the capacitors in the following conditions at all times, and use within 24 months after delivered.

温度/Temperature: 10 ~30°C

湿度/Humidity: 60%max.

(3). 在打开防潮包装后 168 小时内焊接封闭电容器。打开后, 将电容器储存在装有干燥剂和湿敏卡的防潮包装中, 并保持上述状态。

Solder the enclosed capacitors within 168 hours after opening the moisture- proof package. After opening, store the capacitors in moisture- proof package with a desiccant and HIC card and keep the above condition.

(4). 如果储存期超过 12 个月或打开包装后封闭湿敏卡的指示颜色发生变化, 则在焊接前进行烘烤 (60°C×168 小时)

In case the storage period has been exceeded 12 months or the indicator color of a enclosed HIC card has changed when the package has been opened, perform baking (60°Cx168hr) before soldering.

15. 注意事项/Application notes

①. 用户进行的重复耐电压试验可能损坏电容器, 故试验后的电容器不可以当合格品再使用。

Attention is drawn to the fact that repetition of the voltage proof test by the user may damage the capacitor.

②. 电容器在 PCB 板上安装时要求 PCB 板焊盘需与电容器管脚贴焊点吻合, 相反可能会导致电容器与 PCB 板焊接不良, 电容器管脚变形或本体破坏而损坏电容器。

Capacitors mounted on a printed circuit board (PCB) requirements of PCB board welding disc required and capacitor pin paste solder joint agreement, the opposite may cause the capacitor and the PCB board to bad welding and capacitor tube deform the feet or body destruction and damage the capacitor.

③. 避免任何挤压, 弯折, 外部撞击。

Avoid any compressive, tensile or flexural stress.

④. 在电容器上进行树脂成型时, 应事先咨询我司相关技术人员。

Please consult us first if you wish to embed the capacitor in plastic resins.

⑤. 焊接于 PCB 板的电容器不可用力移动或将本体用力倾斜。

Do not move the capacitor after it has been soldered to the board.

⑥. 不可用焊接于 PCB 板后的电容将板提取, 可能破坏电容焊接和包封层破损。

Do not pick up the PC board by the soldered capacitor.

编 号/Number	TRX-3-081	制 定 日 期/Date	2024. 11.26
发 行 版 次/Issue	B2	页 码/Page	Page 27 of 28

16. 陶瓷电容器的一般知识/general knowledge for ceramic Capacitors

1. 容量和损耗测试/for capacitance and Dissipation factor($\tan\delta$) :

1.1 用测试夹具紧密接触或夹住电容两脚进行测试读数，不可用手拿着电容本体进行测试。因手温传给电容本体后会影响到电容的容量和损耗，造成测试结果有出入而引起误判。

The capacitor is tested after be clamped with the test tool, can't take the capacitor's nomenclature for test with hand. Capacitance and dissipation factor are not exact because of temperature in hand and test result is not right.

1.2 耐压测试后的产品在进行容量和损耗测试前必须是电容已经放置 24 小时以上，并且在测试时需将电容两引脚进行短路放电，避免残余电量损坏测试仪表 The capacitor's capacitance and Dissipation factor after voltage tested may not test before the capacitor is stored for 24 hours after voltage test . the capacitor must be discharge between leads before test, or else voltage of remainder attaint test apparatus.

2. 耐电压/for Voltage proof:

先调节好测试用耐压仪的测试电压性质，数值，最大电流和测试时间，再用测试仪两电源输出端夹子夹住电容的两支引脚，且两夹具的内间距不能小于电容脚距（若两夹具的内间距小于电容脚距时，在充电测试中会因爬电距离过小产生飞弧，瞬间在电容内部产生大电流而破坏电容结构。

Charge to capacitor after AC or DC Voltage, value, time and current are seted in testapparatus, clamping capacitor's lead with clamp for test apparatus output . Spacebetween clamps for test apparatus output must meet standard , or else flashover will be happened between two leads if space is too small . Capacitor's configuration wasbe destroyed if great current will be happened in capacitor for moment.

17. 电容高压测试操作指引/Voltage proof test guide

A. 正确方法

Correct Method



操作说明 Operate explain:

1. 设定耐压仪测试电压， 电流， 测试时间。
Set up test voltage , current and time in high voltage instrument.
2. 将电容两引脚夹于高压输出端夹具上，使引脚与夹具接触牢固
The two pins of capacitor are nipped in fixture of high voltage instrumen.
3. 按下启动按钮， 电压输出， 电容进行高压测试， 测试时间完成时， 耐压仪自动切断电压输出
Give the start button a slight press and the capacitor changed and tested, high voltage instrument stop output when the time arrived.

编 号/Number	TRX-3-081	制定日期/Date	2024. 11.26
发行版次/Issue	B2	页 码/Page	Page 28 of 28

B. 错误方法

Error Method



描述 Operate explain:

直接用带电的测试棒去接触电容的两引脚进行测试 Capacitor was test with high voltage test probe for electriferous touch the two pins of capacitor.

危害 Harm:

在测试棒与引脚为接触，但距离又很近时，会产生拉弧现象，瞬间产生大电流，对电容产生破坏作用，部分现场不良，部分产生隐患，在生产或客户使用时产生不良。

It will happen flashover in high voltage test probe and two pins of capacitor. One part of capacitors will hazardous. It will emerge bad in used.